

HI98165

Professional pH and Temperature
Meter for Cheese



INSTRUCTION MANUAL

**Dear
Customer,**

Thank you for choosing a Hanna Instruments product.

Please read this instruction manual carefully before using the instrument.

This manual will provide you with the necessary information for correct use of the instrument, as well as a precise idea of its versatility.

If you need additional technical information, do not hesitate to e-mail us at tech@hannainst.com or view our worldwide contact list at www.hannainst.com.

All rights are reserved. Reproduction in whole or in part is prohibited without the written consent of the copyright owner, Hanna Instruments Inc., Woonsocket, Rhode Island, 02895, USA.

PRELIMINARY EXAMINATION	4
SAFETY MEASURES	4
GENERAL DESCRIPTION	5
FUNCTIONAL DESCRIPTION	6
SPECIFICATIONS	8
OPERATIONAL GUIDE	9
pH CALIBRATION	11
pH BUFFER TEMPERATURE DEPENDENCE	21
GOOD LABORATORY PRACTICE (GLP)	22
SETUP	23
LOGGING	33
AUTOEND	34
mV AND TEMPERATURE CALIBRATION (FOR TECHNICAL PERSONNEL ONLY)	35
PC INTERFACE	38
BATTERIES REPLACEMENT	42
TEMPERATURE CORRELATION FOR pH SENSITIVE GLASS	43
ELECTRODE CONDITIONING AND MAINTENANCE	44
TROUBLESHOOTING GUIDE	46
ACCESSORIES.....	48

Remove the instrument from the packing material and examine it carefully to make sure that no damage has occurred during shipping. If there is any damage, please notify us.

Each instrument is supplied with:

- [FC2423](#) Pre-amplified pH and temperature probe with stainless steel sheath
- [HI700642](#) Cleaning solution for cheese residues (food industry) (2 pcs.)
- [HI92000](#) PC Software
- [HI920015](#) USB cable
- pH 4.01 & 7.01 Buffer solutions (230 mL each)
- 100 mL Beaker (2 pcs.)
- 1.5V AA Batteries (4 pcs.)
- [HI720165](#) Hard carrying case
- Instruction Manual and Quick Reference Guide
- Certificate
- Instrument Quality Certificate

Note: Save all packing material until you are sure that the instrument functions correctly. All defective items must be returned in the original packing with the supplied accessories.

Before using this product, make sure that it is entirely suitable for your specific application and for the environment in which it is used.

Operation of this instrument may cause interference to other electronic equipment, requiring the operator to take steps to correct interference. Any variation introduced by the user to the supplied equipment may degrade the instrument's EMC performance.

To avoid damages or burns, do not put the instrument in microwave ovens. For your and the instrument's safety, do not use or store the instrument in hazardous environments.

The [HI98165](#) is a portable pH and temperature meter designed for pH measurement in cheese. Throughout the cheese making process, pH control is critical to ensure consistent fermentation and food safety. If the pH is too low, the cheese may be prone to a brittle or pasty texture, as well as growth of mold after packaging. If the pH is too high, the cheese may become too firm, and can potentially be dangerous for consumption due to the risk of pathogen formation. The pH must be carefully monitored to detect deviation from the optimal range, which can create problems with texture, taste and public safety of cheese.

The [HI98165](#) meter is provided with a series of new diagnostic features which add an entirely new dimension to the measurement of pH, by allowing the user to dramatically improve the reliability of the measurement:

- Seven standard buffers (pH 1.68, 4.01, 6.86, 7.01, 9.18, 10.01 and 12.45) for calibration.
- pH calibration up to five calibration points (see instrument specifications).
- Custom calibration with up to five custom buffers.
- Messages on the graphic LCD for an easy and accurate calibration.
- Cal Check™ Diagnostic features to alert the user when the electrode needs cleaning.
- Optional user enabled “Outside Calibration Range” warning.
- Monitoring of the electrode aging.
- User selectable “Calibration Time Out” to remind when a new calibration is necessary.

This meter is supplied with a pH electrode specifically designed for use with cheese. The [FC2423](#) pH electrode with a built-in temperature sensor features a stainless steel body with a conic glass tip which allows for penetrations into solids, semi-solids and emulsions for direct measurement of pH in cheese products.

Other features include:

- Log on demand up to 200 samples (100 pH and 100 mV).
- Auto Hold feature, to freeze first stable reading on the LCD.
- GLP feature, to view last calibration data for pH.
- PC interface.

FRONT VIEW

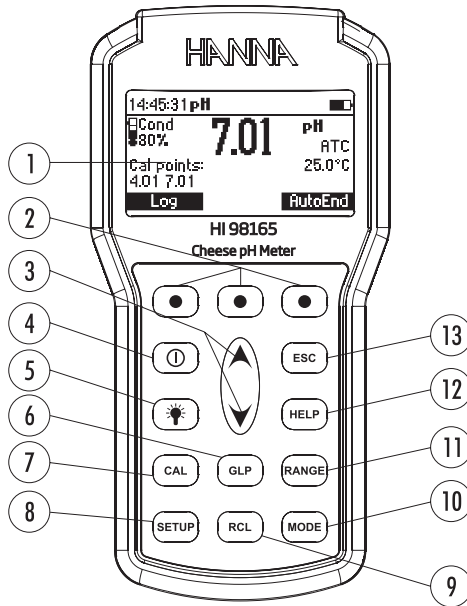

- 1) Liquid Crystal Display (LCD).
- 2) Functional keys.
- 3) ▲/▼ keys to scroll through calibration buffers, setup options, manual temperature compensation and logged data.
- 4) **ON/OFF** (⏻) key, to turn the instrument ON and OFF.
- 5) **LIGHT** (💡) key to toggle display backlighting.
- 6) **GLP** key, to display Good Laboratory Practice information.
- 7) **CAL** key, to enter/exit calibration mode.
- 8) **SETUP** key, to enter/exit SETUP mode.
- 9) **RCL** key, to enter/exit view logged data mode.
- 10) **MODE** key to change pH resolution.
- 11) **RANGE** key, to switch between pH and mV range.
- 12) **HELP** key to enter/exit contextual help.
- 13) **ESC** to leave current mode, exit calibration, setup, help, etc.

TOP VIEW

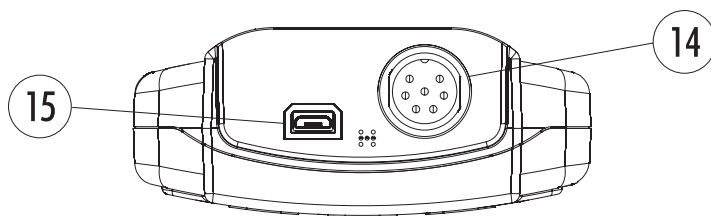

14) Electrode quick connect **DIN** connector.

15) USB connector.

pH	Range	-2.0 to 20.0 pH / -2.00 to 20.00 pH / -2.000 to 20.000 pH
	Resolution	0.1 pH / 0.01 pH / 0.001 pH
	Accuracy	± 0.1 pH / ± 0.01 pH / ± 0.002 pH
Temperature	Range	-20.0 to 120.0 °C (-4.0 to 248.0 °F)
	Resolution	0.1 °C (0.1 °F)
	Accuracy	± 0.4 °C (± 0.8 °F) (excluding probe error)
mV	Range	± 2000
	Resolution	0.1 mV
	Accuracy	± 0.2 mV
pH Calibration	Up to five point calibration, seven standard buffers available (pH 1.68, 4.01, 6.86, 7.01, 9.18, 10.01, 12.45), and five custom buffers	
Slope Calibration	From 80 to 110%	
Temperature Compensation	Automatic	
pH Electrode	FC2423 pH & temperature	
LOG	On demand, 200 samples (100 pH and 100 mV)	
Input Impedance	$10^{12} \Omega$	
Battery Type/Life	1.5V AA batteries (4 pcs.) / approx. 200 hours of continuous use without backlight (50 hours with backlight)	
Auto Power Off	User selectable: 5, 10, 30, 60 minutes or disabled	
PC Interface	opto-isolated USB	
Dimensions	185 x 93 x 35.2 mm (7.3 x 3.6 x 1.4")	
Weight	400 g (14.2 oz)	
Environment	0 to 50 °C (32 to 122 °F) max. RH 100% IP67	

INITIAL PREPARATION

The instrument is supplied complete with 1.5V AA (4 pcs.) batteries. For placing the batteries inside the meter, see page 42.

Make sure that the protective micro USB cover is used when not connected to a computer to ensure waterproof protection.

For **HI98165** connect the pH/temperature electrode to the DIN connector.

Turn the instrument ON by pressing **ON/OFF** key.

At start-up the display will show the Hanna logo for a few seconds followed by the percentage indication of the remaining battery life, then enters the measurement mode.

After measurement switch the instrument off, clean the electrode and store it with a few drops of **HI70300** storage solution in the protective cap (see page 45).

The Auto Power Off feature turns the instrument off after a set period (default 30 min) with no button pressed to save battery life. To set another period or to disable this feature, see **SETUP** menu on page 23.

The Auto Light Off backlight feature turns the backlight off after a set period (default 1 min) with no buttons pressed. To set another period or to disable this feature, see **SETUP** menu on page 23.

pH MEASUREMENTS

To take a pH measurement remove the electrode protective cap and simply submerge the tip of the electrode (4 cm/1 1/2") into the sample to be tested.

Press **RANGE** key to choose between pH and mV ranges.

Use **MODE** key to select the pH resolution.

Allow time for the electrode to adjust and reading to stabilize (hourglass symbol turns off).

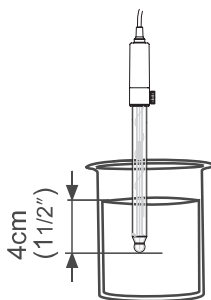

On the pH screen are displayed:

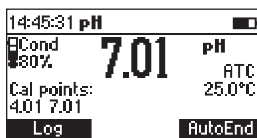

- pH reading with the selected resolution.
- Temperature reading in the selected unit (°C or °F).
- Electrode condition during the calibration day.
- The buffers used in last pH calibration (if feature is enabled in **SETUP**).
- Battery level indicator.
- Available functional keys.

In order to take more accurate pH measurements, make sure that the instrument is calibrated (see page 11 for calibration details).

It is recommended that the electrode is always kept moist and rinsed thoroughly with the sample to be measured before use.

The pH reading is directly affected by temperature. For accurate pH measurements, temperature must be taken into consideration. If the sample temperature is different from the temperature at which the pH electrode was kept, allow a few minutes to reach thermal equilibrium.

TEMPERATURE MEASUREMENTS

For **HI98165** the temperature sensor is connected through DIN socket.

*Note: The temperature can be displayed in Celsius degrees (°C) or in Fahrenheit degrees (°F) (see **SETUP** for details, page 23).*

BACKLIGHT FEATURE

The instrument is provided with a Backlight feature, which can be easily toggled on and off through the keyboard by pressing **LIGHT**.

*Note: The backlight automatically shuts off after a set period (see **SETUP** for details, page 23) with no buttons pressed.*

It is recommended to calibrate the instrument frequently, especially if high accuracy is required. The pH range should be recalibrated:

- Whenever the pH electrode is replaced.
- At least once a week.
- After testing aggressive chemicals.
- When calibration alarm time out is expired - "CAL DUE" blinks (if feature is enabled in **SETUP**).
- If "Outside Cal Range" message blinks during pH measurement (the measurement range is not covered by current calibration, if feature is enabled in **SETUP**).

PROCEDURE

HI98165 instrument offers a choice of seven standard buffers (pH 1.68, 4.01, 6.86, 7.01, 9.18, 10.01 and 12.45). The meter allow the user to set up to five custom buffers. The set custom buffers are the buffer values at 25 °C.

When a custom buffer is selected during calibration, the **Custom** functional key is displayed on the LCD. Press **Custom** key in order to enter custom buffer changing mode. Use ▲/▼ keys to change the value in a ± 1.00 pH window, in according with the temperature reading and then **Accept**. Press **ESC** to leave custom buffers value unchanged.

For accurate pH measurements, it is recommended to perform a calibration with buffers that bracket the expected pH value. At least two point calibration is recommended.

The instrument will automatically skip the buffers used during calibration and the buffers which are in a ± 0.2 pH window around one of the calibrated buffers.

- Remove protective cap and rinse the electrode with distilled or deionized water.
- Pour small quantities of selected buffer solutions into clean beakers. For accurate calibration use two beakers for each buffer solution, the first one for rinsing the electrode and the second one for calibration.

FIVE POINT CALIBRATION

- Immerse the pH electrode approximately 4 cm (1½") into a buffer solution of your choice (pH 1.68, 4.01, 6.86, 7.01, 9.18, 10.01, 12.45 or a custom buffer) and stir gently.

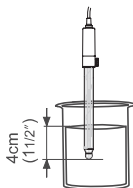

- Press **CAL**. The instrument will display the measured pH, the LCD first expected buffer and the temperature reading.

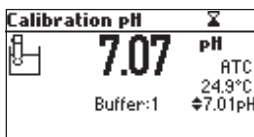

- If necessary, press the ▲/▼ keys to select a different buffer value.
- The "Σ" tag will blink on the LCD until the reading is stable.
- When the reading is stable and within range of the selected buffer, **CFM** functional key is displayed.

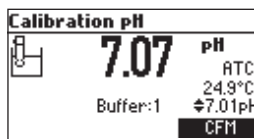

- Press **CFM** to confirm first point.
- The calibrated value and the second expected buffer value is then displayed on the LCD.

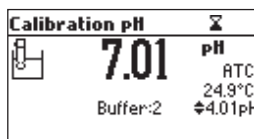

- After the first calibration point is confirmed, immerse the pH electrode probe approximately 4 cm (1½”) into the second buffer solution and stir gently.
- If necessary, press the ▲/▼ keys to select a different buffer value.
- The “Σ” tag will blink on the LCD until the reading is stable.

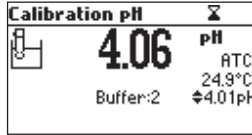

- When the reading is stable and within range of the selected buffer, the CFM functional key is displayed.

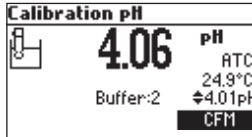

- Press CFM to confirm calibration.
- The calibrated value and the third expected buffer value will be displayed.

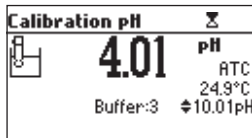

- After the second calibration point is confirmed, immerse the pH electrode approximately 4 cm (1½”) into the third buffer solution and stir gently.

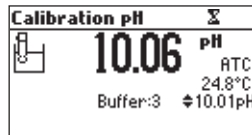

- If necessary, press the ▲/▼ keys to select a different buffer value.
- The “Σ” tag will blink on the LCD until the reading is stable.
- When the reading is stable and within range of the selected buffer, the **CFM** functional key is displayed.

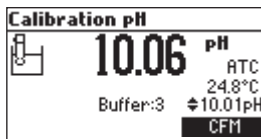

- Press **CFM** to confirm calibration.
- The calibrated value and the fourth expected value will be displayed.

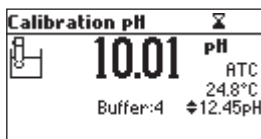

- After the third calibration point is confirmed, immerse the pH electrode approximately 4 cm (1½”) into the fourth buffer solution and stir gently.
- If necessary, press the ▲/▼ keys to select a different buffer value.
- The “Σ” tag will blink on the LCD until the reading is stable.

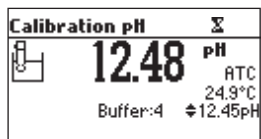

- When the reading is stable and within range of the selected buffer, the **CFM** functional key is displayed.

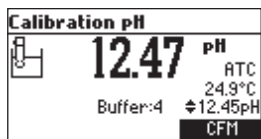

- Press **CFM** to confirm calibration.

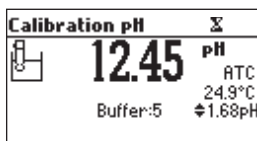

- The calibrated value and the fifth expected buffer will be displayed.
- After the fourth calibration point is confirmed, immerse the pH electrode approximately 4 cm (1½”) into the fifth buffer solution and stir gently.

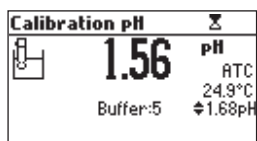

- If necessary, press the ▲/▼ keys to select a different buffer value.
- The “Σ” tag will blink on the LCD until the reading is stable.
- When the reading is stable and within range of the selected buffer, the **CFM** functional key is displayed.

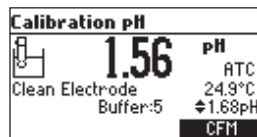

- Press **CFM** to confirm calibration.
- The instrument stores the calibration values and returns to normal measurement mode.

FOUR, THREE, TWO or ONE POINT CALIBRATION

- Proceed as described in “FIVE POINT CALIBRATION” section.
- Press **CAL** or **ESC** after the appropriate accepted calibration point. The instruments will return to measurement mode and will memorize the calibration data.

FIRST POINT CALIBRATION

Two **SETUP** options are available to determine how the previous calibration will be affected by a subsequent one point calibration. These options are **Replace** and **Offset**.

If the **Replace** option is selected, the slopes between current buffer and nearest lower and higher buffers will be recalculated.

If the **Offset** option is selected, an electrode offset correction is performed keeping unchanged the existing slopes.

ERROR SCREENS

Wrong buffer

The calibration cannot be confirmed.

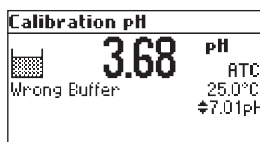

The pH reading is not within range of the selected buffer. Select another buffer using the **▲/▼** keys or change the buffer.

Electrode Dirty/Broken alternatively with Buffer Contaminated

The calibration cannot be confirmed.

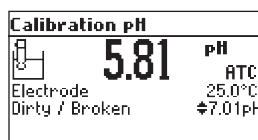
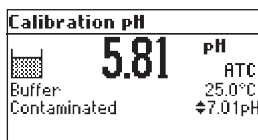

The offset of the electrode is not in the accepted range. Check if the electrode is broken or clean it following the Cleaning Procedure (see page 45). Check the quality of the buffer. If necessary, change the buffer.

Wrong slope

The calibration cannot be confirmed.

Calibration pH		
	4.6	pH
		ATC
Wrong Slope		25.0°C
		±4.01pH

The evaluated slope is less than the lowest accepted value (80% of default slope).

Calibration pH		
	3.3	pH
		ATC
Wrong Slope		25.0°C
		±4.01pH

The evaluated slope is more than the highest accepted value (110 % of default slope).

Wrong old slope

An inconsistency between new and previous (old) calibration is detected. Clear old calibration parameters and proceed with the calibration from the current point. The instrument will keep all confirmed values during current calibration.

Calibration pH		
	0.5	pH
		ATC
Wrong Old Slope		25.0°C
		±1.68pH
		Clear

Note: For one point calibration the electrode condition is not displayed in the measurement screen. Each time a buffer is confirmed, the new calibration parameters replace the old calibration parameters of the corresponding buffer.

If the current confirmed buffer has no correspondence in the existing stored calibration and this is not full, the current buffer is added to the existing stored calibration.

If the existing stored calibration is full (five calibration points), after confirming the calibration point, the instrument will ask which buffer will be replaced by current buffer.

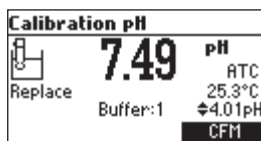

Press ▲/▼ keys to select another buffer to be replaced.

Press **CFM** to confirm the buffer that will be replaced.

Press **CAL** or **ESC** to leave replace mode. In this case, the buffer will not be memorized.

Note: The replaced buffer is not removed from calibration list and it can be selected for the next calibration points.

WORKING WITH CUSTOM BUFFERS

If at least one custom buffer was set in **SETUP** menu, it can be selected for calibration by pressing the ▲/▼ keys. The **Custom** functional key will be displayed.

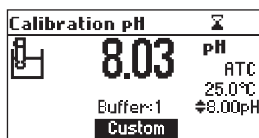

Press **Custom** if you want to adjust the buffer value according with current temperature.

Use the ▲/▼ keys to change the buffer value.

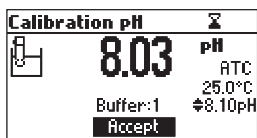

Press **Accept** to accept new value or **ESC** to exit changing mode.

Note: Custom buffer value can be adjusted in a ±1.00 pH window, around the set value.

WORKING WITH MILI pH BUFFERS

If calibration is invoked from mili pH range, the calibration buffer can be modified in a ± 0.020 pH range in according with the label on the calibration buffer.

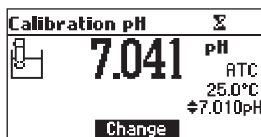

Press **Change** to enter buffer adjust mode.

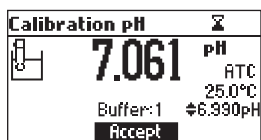

Use $\blacktriangle/\blacktriangledown$ keys to change the buffer value.

Press **Accept** to accept new value or **ESC** to exit adjusting mode.

CLEAR CALIBRATION

Press **Clear** functional key when displayed to clear old calibrations.

All old calibrations, are cleared and the instrument continues calibration. The points confirmed in current calibration are kept.

Note: If Clear calibration is invoked during the first calibration point, the instrument returns to measurement mode.

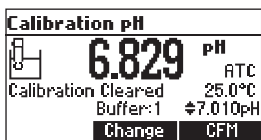

ELECTRODE CONDITION

The display is provided with an icon, and a numeric value (unless the feature is disabled) which gives an indication of the electrode status after calibration.

The “condition” remains active until the end of the calibration day.

Note: The electrode condition is evaluated only if current calibration includes at least two standard buffers.

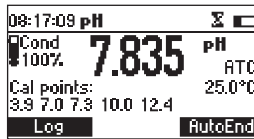

CLEAN ELECTRODE WARNING

Each time pH calibration is performed, the instrument internally compares the new calibration with the one previously stored.

When this comparison indicates a significant difference, the “Clean Electrode” warning message is displayed to advise the user that the pH electrode may need to be cleaned (see ELECTRODE CONDITIONING AND MAINTENANCE section for details, page 44).

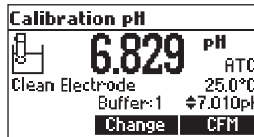

After cleaning, perform a new calibration.

Note: If the calibration data are cleared, the comparison is done with the default values.

The temperature has an effect on pH. The calibration buffer solutions are affected by temperature changes to a lesser degree than normal solutions.
 During calibration the instrument will automatically calibrate to the pH value corresponding to the measured temperature.

TEMP		pH BUFFERS						
°C	°F	1.68	4.01	6.86	7.01	9.18	10.01	12.45
0	32	1.67	4.01	6.98	7.13	9.46	10.32	10.38
5	41	1.67	4.00	6.95	7.10	9.39	10.25	13.18
10	50	1.67	4.00	6.92	7.07	9.33	10.18	12.99
15	59	1.67	4.00	6.90	7.05	9.27	10.12	12.80
20	68	1.68	4.00	6.88	7.03	9.22	10.06	12.62
25	77	1.68	4.01	6.86	7.01	9.18	10.01	12.45
30	86	1.68	4.02	6.85	7.00	9.14	9.96	12.29
35	95	1.69	4.03	6.84	6.99	9.11	9.92	12.13
40	104	1.69	4.04	6.84	6.98	9.07	9.88	11.98
45	113	1.70	4.05	6.83	6.98	9.04	9.85	11.83
50	122	1.71	4.06	6.83	6.98	9.01	9.82	11.70
55	131	1.72	4.08	6.84	6.98	8.99	9.79	11.57
60	140	1.72	4.09	6.84	6.98	8.97	9.77	11.44
65	149	1.73	4.11	6.84	6.99	8.95	9.76	11.32
70	158	1.74	4.12	6.85	6.99	8.93	9.75	11.21
75	167	1.76	4.14	6.86	7.00	8.91	9.74	11.10
80	176	1.77	4.16	6.87	7.01	8.89	9.74	11.00
85	185	1.78	4.17	6.87	7.02	8.87	9.74	10.91
90	194	1.79	4.19	6.88	7.03	8.85	9.75	10.82
95	203	1.81	4.20	6.89	7.04	8.83	9.76	10.73

During calibration the instrument will display the pH buffer value at 25 °C.

GLP is a set of functions that allows storage and retrieval of data regarding the maintenance and status of the electrode.

All data regarding the pH calibration is stored for the user to review when necessary.

EXPIRED CALIBRATION

The instrument is provided with a real time clock (RTC), in order to monitor the time elapsed since the last pH calibration.

The real time clock is reset every time the instrument is calibrated and the “Expired Calibration” status is triggered when the instrument detects a calibration time out. The “CAL DUE” tags will start blinking to warn the user that the instrument should be recalibrated.

The calibration time out can be set (see **SETUP** for details, page 23) from 1 to 7 days or can be disabled.

For example, if a 4 days time out has been selected, the instrument will issue the alarm exactly 4 days after the last calibration.

However, if at any moment the expiration value is changed (e.g. to 5 days), then the alarm will be immediately recalculated and appear 5 days after the last calibration.

Notes: When the instrument is not calibrated or calibration is cleared (default values loaded) there is no “Expired Calibration”, and the display always shows the “CAL DUE” tags blinking.

When an abnormal condition in the RTC is detected, the instrument forces the “Expired Calibration” status.

LAST pH CALIBRATION DATA

The last pH calibration data is stored automatically after a successful calibration.

To view the pH calibration data, press **GLP** when the instrument is in the measurement mode.

Last pH cal	Buffer[pH]
Date: 2015/05/31	7.01*
Time: 10:03:04	4.01
Cal Expire: Disabled	7.01
Offset: -1.4mV	
Slope: 99.3%	

The instrument will display a lot of data including calibration buffer, offset, slope, electrode condition.

Note: Buffers displayed in video inverse mode are from previous calibrations. The custom buffers are marked with an “” on the right side of the buffer value. “No user calibration” message is displayed if all calibration are cleared or the instrument was not calibrated.*

Setup mode allows viewing and modifying the measurement parameters.

The following table lists the general **SETUP** parameters, their valid range and the factory default settings.

	Description	Valid value	Default
Backlight	Backlight level	0 to 7	4
Contrast	Contrast level	0 to 20	10
Auto light off	Time until backlight is ON	1, 5, 10, 30 min	1
Auto power off	Time after the instrument is powered OFF	Disabled 5, 10, 30, 60 min	30
Date/Time		01.01.2000 to 12.31.2099 00:00 to 23:59	current date/time
Time Format		AM/PM or 24 hours	24 hours
Date Format		DD/MM/YYYY MM/DD/YYYY YYYY/MM/DD YYYY-MM-DD Mon DD, YYYY DD-Mon-YYYY YYYY-Mon-DD	YYYY/MM/DD
Language	Message display language	Up to four languages	English
Temperature unit		°C or °F	°C
Beep ON	Beeper Status	Enabled or Disabled	Disabled
Instrument ID	Instrument identification	0000 to 9999	0000
Baud Rate	Serial Communication	600, 1200, 2400, 4800, 9600	9600
Meter information	Displays general information		

The following table lists the specific range parameters.

Item	Description	Valid value	Default
Calibration Timeout	Number of days after Calibration warning is displayed	Disable, 1 to 7 days	Disable
First point mode	Management of 1 point calibration	Replace or offset	Replace
Custom buffer	Custom buffer setting	Max. 5 buffers	No
View calibration points	Display calibration points	Enable or disabled	Enable
Display Out of Cal. Range Warning		Enable or disabled	Enable

GENERAL PARAMETER SCREENS

Backlight

Highlight *Backlight*.

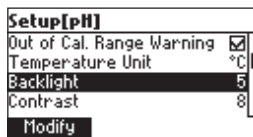

Press **Modify**.

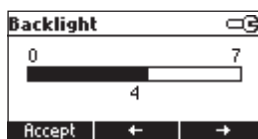

Use ← / → keys to change the intensity then press **Accept** to confirm.
Press **ESC** to leave without changing.

Contrast

Highlight *Contrast*.

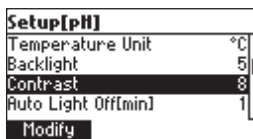

Press **Modify**.

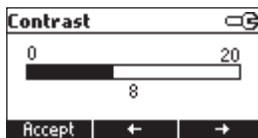

Use ← / → keys to change contrast then press **Accept** to confirm.
Press **ESC** to leave without changing.

Auto Light Off

Highlight *Auto Light Off*.

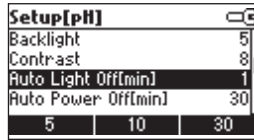

Press 5, 10 or 30 to change settings.

Auto Power Off

Highlight *Auto Power Off*.

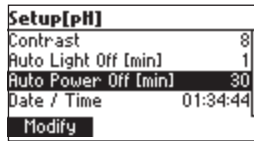

Press **Modify**.

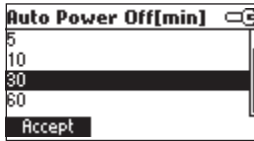

Press ▲/▼ keys to select interval then press **Accept**.

Press **ESC** to leave without changing.

Date/Time

Highlight *Date/Time*.

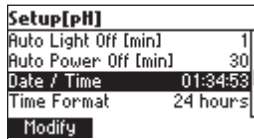

Press **Modify**.

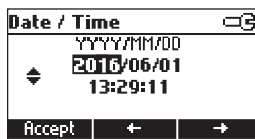

Use ←/→ keys to select item.

Use ▲/▼ keys to change focused values.

Press **Accept** to confirm new setting, or **ESC** to leave without changing.

Time Format

Highlight *Time Format*.

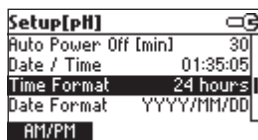

Press displayed functional key to change the option.

Date Format

Highlight *Date Format*.

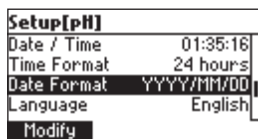

Press **Modify**.

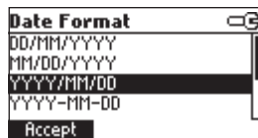

Use ▲/▼ keys to select date format then press **Accept**.

Press **ESC** to leave without changing.

Language

Highlight *Language*.



Use the desired functional key to change the option. Wait until new language is loaded. If language load fails the instrument will try to reload current language.

If any language can't be loaded, the instrument will work in safe mode. In this mode all messages are displayed in English and **Help** is not available.

Temperature Unit

Highlight *Temperature Unit*.

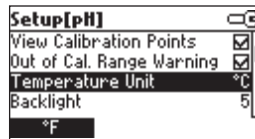

Press the displayed functional key in order to change the temperature unit.

Beep On

Highlight *Beep On*.

Press the displayed functional key to enable/disable beep.

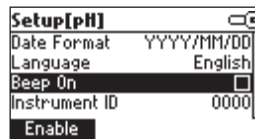

When enabled, beep sounds as a short beep every time a key is pressed or when the calibration can be confirmed.

A long beep alert that the pressed key is not active or a wrong condition is detected while in calibration.

Instrument ID

Highlight *Instrument ID*.

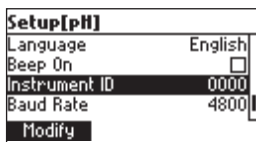

Press **Modify**.

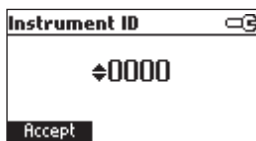

Use ▲/▼ keys to change the instrument ID.
Press **Accept** to confirm or **ESC** to exit without saving.

Baud Rate

Highlight *Baud Rate*.

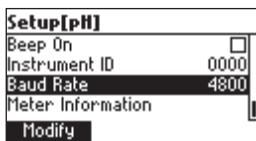

Press **Modify**.

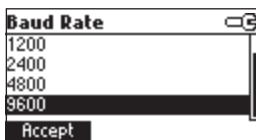

Use ▲/▼ keys to select the desired communication baud.
Press **Accept** to confirm or **ESC** to exit.

Meter information

Highlight *Meter Information*.

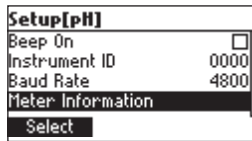

Press **Select**.

The meter informations are displayed:

- firmware version
- language version
- mV and temperature factory calibration time/date
- battery capacity

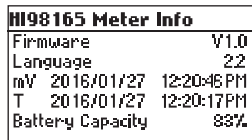

RANGE SPECIFIC PARAMETERS SCREENS

Calibration Timeout

Highlight *Calibration Timeout*.

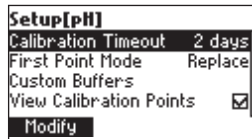

Press **Modify**.

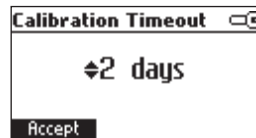

Use **▲/▼** keys to set desired value.

Press **Accept** to confirm or **ESC** to return without saving.

Note: If enabled “CAL DUE” warning will be displayed, the set number of days after calibration is over passed.

First Point Mode

Highlight *First Point Mode*.

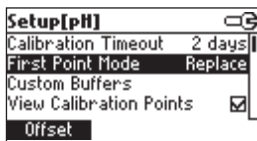

Press the displayed functional key in order to change the option.

If **Replace** option is selected, the slopes between current buffer and nearest lower and higher buffers will be recalculated.

If the **Offset** option is selected, an electrode offset correction is performed keeping unchanged the existing slopes.

Custom Buffers

Highlight *Custom Buffers*.

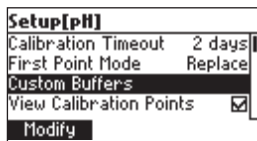

Press **Modify**.

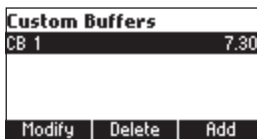

Press **Delete** to delete custom buffer value.

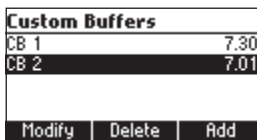

Press **Add** to add a new buffer to the list (max 5).

Press **Modify** to set custom buffer value.

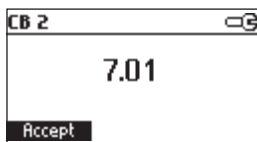

Use **▲/▼** keys to change the value.

Press **Accept** to confirm custom buffer value or **ESC** to exit without saving.

View Calibration Points

Highlight *View Calibration Points*.

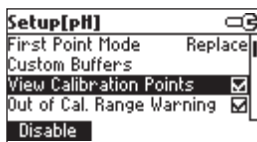

Press the displayed functional key to change option.

If option is enabled the calibration buffers corresponding to the last calibration are displayed in the pH measurement screen.

Out of Calibration Range Warning

Highlight *Out of Cal. Range Warning*.

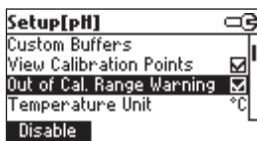

Press the displayed functional key in order to change option.

If enabled, the **"Out Cal Range"** message will be displayed if the pH reading is outside.

Approximately 1 pH unit, from the lowest and highest pH buffer value used for calibration. For single point calibration the message will be displayed for pH values less than 4 or greater than 10.

This feature allows the user to log pH measurements. All logged data can be transferred to a PC through the **USB** port using **HI92000** application.

The maximum logging space is 200 (100 pH and 100 mV) for **HI98165** record locations.

LOGGING THE CURRENT DATA

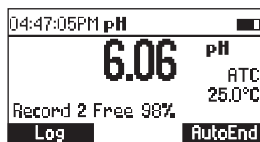

To store the current reading into memory, press **LOG** while in measurement mode.

The instrument will display for few seconds the record number and the amount of the free log space.

If the LOG space is full, the “**Log space is full**” message will be displayed for few seconds when **Log** key is invoked. Enter View Logged Data Mode and delete records in order to free log space.

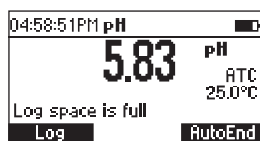

VIEW LOGGED DATA

Press **RCL** to retrieve the information stored while in measurement mode.

	pH	Date
1	6.06	2006/01/18
2	6.06	2006/01/18
3	6.06	2006/01/18
4	6.06	2006/01/18

At the bottom of the screen, there are three buttons: 'Delete All', 'Delete', and 'More'.

The list of records is displayed.

If no data were logged, the instrument will display “**No Records!**” message.

Use **▲/▼** keys to scroll between the records from the list.

Press **Delete All** to enter Delete All screen.

Press **Delete** to enter Delete records screen.

Press **More** to view more information of the focused record.

If **More** is pressed.

Record number: 1	
2016/01/01	02:38:06
7.00pH	23.4°C
7.8mV	
Offset: 7.8mV	
Slope: 100.0%	

Use **▲/▼** keys to scroll between complete log information.

If **Delete** is pressed.

Delete Record?		
1	6.06	2006/01/18
2	6.06	2006/01/18
3	6.06	2006/01/18
4	6.06	2006/01/18

CFM

Use **▲/▼** key to focus the record to be deleted and then press **CFM**.

Press **ESC** to exit.

If **Delete All** is pressed the instrument asks for confirmation.

Press **CFM** to confirm or **ESC** to exit without deleting.

To freeze the first stable reading on the LCD press **AutoEnd** while the instrument is in measurement mode.

05:10:48PM pH		Wait	⊗
Cond	7.01	pH	
80%		ATC	
Cal points:		25.0°C	
4.01 7.01			

Log **Continue**

The **"Wait"** symbol will blink until the reading is stable.

When the reading is stable, **"Hold"** icon will be displayed.

05:10:48PM pH		Hold	⊞
Cond	7.01	pH	
80%		ATC	
Cal points:		25.0°C	
4.01 7.01			

Log **Continue**

Press **Continue** in order to enter continuous reading mode.

IMPORTANT NOTE: This calibration procedure requires the use of a voltage simulator and a digital volt meter. The digital volt meter should be certified for accuracy.

For factory calibration contact your Hanna Instruments office.

All the instruments are factory calibrated for mV and temperature.

Hanna's temperature sensors are interchangeable and no temperature calibration is needed when they are replaced.

If the temperature is inaccurate, calibration should be performed.

For an accurate recalibration, contact your local Hanna Instruments Office or follow the instructions below.

ENTER CALIBRATION MODE

With the instrument off, press and hold down the ▲/▼ then power on the instrument. The calibration screen is displayed. Highlight "T" and then press Modify to enter in the temperature calibration mode.

Calibration	
Date / Time	01:34:53
T	
mV	
Modify	

TEMPERATURE CALIBRATION

- Prepare a vessel containing ice and water and another one containing hot water (at approximately 50 °C or 122 °F). Place insulation material around the vessels to minimize temperature changes.
- Use a calibrated thermometer with a resolution of 0.1 °C as a reference thermometer.

Temperature	Σ
0.0	°C
Point:1	0.0°C

- Immerse the pH probe including temperature sensor into the vessel with ice and water as close as possible to the reference thermometer. Allow a few seconds for the probe to stabilize.
- Use the ▲/▼ keys to set the calibration point value to that of ice and water mixture, measured by the reference thermometer. When the reading is stable and within range of the selected calibration point, the **CFM** functional key is displayed.

- Press **CFM** to confirm.
- The second expected calibrated point is displayed.

Temperature	Σ
0.0	°C
Point:2	50.0°C

- Immerse the pH probe including temperature sensor into the second vessel as close as possible to the reference thermometer. Allow a few seconds for the probe to stabilize.

Temperature	Σ
49.8	°C
Point:2	50.0°C

- Use the ▲/▼ keys to set the calibration point value to that of the hot water.
- When the reading is stable and within range of the selected calibration point, **CFM** functional key is displayed.

Temperature	Σ
49.8	°C
Point:2	50.0°C
	CFM

- Press **CFM** to confirm. The instrument returns to measurement mode.

Note: Use ▲/▼ keys to change calibration point if necessary (± 10.0 °C) around the point. If the reading is not within range of the selected calibration point, "Wrong" message will blink. Change the pH probe including temperature sensor and restart calibration.

mV CALIBRATION

A two point calibration can be performed at 0 mV and 1800 mV.

- Attach to the BNC connector a mV simulator with an accuracy of ± 0.1 mV.
- Enter the calibration screen. Highlight **mV** and then press **Modify** to enter in the mV calibration mode.
- Set 0.0 mV on the simulator.
- When the reading is stable and within range of the selected calibration point, the **CFM** functional key is displayed.
- Press **CFM** to confirm. The second calibration point of 1800 mV will be displayed.
- Set 1800.0 mV on the simulator.
- When the reading is stable and within range of the selected calibration point, the **CFM** functional key is displayed.
- Press **CFM** to confirm. The instrument returns to calibration screen.
- Press **ESC** to return to measurement mode.

Notes: If the reading is not within range of the selected calibration point, "WRONG" tag will blink. Verify calibration condition or contact your vendor if you cannot calibrate. Press CAL or ESC in any moment of the calibration process. The instrument will return in the measurement mode.

Data transmission from the instrument to the PC can be done with the **HI92000** Windows® compatible software (optional). **HI92000** also offers graphing and on-line help feature. Data can be exported to the most popular spreadsheet programs for further analysis. To connect your instrument to a PC, use an **USB** cable connector. Make sure that your instrument is switched off and plug one connector to the instrument **USB** socket and the other to the serial or USB port of your PC.

Note: If you are not using Hanna Instruments HI92000 software, please see the following instructions.

SENDING COMMANDS FROM PC

It is also possible to remotely control the instrument with any terminal program. Use an USB cable to connect the instrument to a PC, start the terminal program and set the communication options as follows: 8, N, 1, no flow control.

COMMAND TYPES

To send a command to the instrument follow the next scheme:

<command prefix> <command> <CR>

where: <command prefix> is the 16 ASCII character

<command> is the command code.

Note: Either small or capital letters can be used.

SIMPLE COMMANDS

KF1	Is equivalent to pressing functional key 1
KF2	Is equivalent to pressing functional key 2
KF3	Is equivalent to pressing functional key 3
RNG	Is equivalent to pressing RANGE key
MOD	Is equivalent to pressing MODE key
CAL	Is equivalent to pressing CAL key
UPC	Is equivalent to pressing the UP arrow key
DWC	Is equivalent to pressing the DOWN arrow key
RCL	Is equivalent to pressing RCL key
SET	Is equivalent to pressing SETUP key
CLR	Is equivalent to pressing CLR key

- OFF** Is equivalent to pressing **OFF** key
- CHR xx** Change the instrument range according with the parameter value (xx):
- xx=00 pH range/0.001 resolution
 - xx=01 pH range/0.01 resolution
 - xx=02 pH range/0.1 resolution
 - xx=03 mV range

The instrument will answer for these commands with:

<STX> <answer> <ETX>

where:

<STX> is 02 ASCII code character (start of text)

<ETX> is 03 ASCII code character (end of text)

<answer>:

<ACK> is 06 ASCII code character (recognized command)

<NAK> is 21 ASCII code character (unrecognized command)

<CAN> is 24 ASCII code character (corrupted command)

COMMANDS REQUIRING AN ANSWER

The instrument will answer for these commands with:

<STX> <answer> <checksum> <ETX>

where the checksum is the bytes sum of the answer string sent as 2 ASCII characters.

All the answer messages are with ASCII characters.

- RAS** Causes the instrument to send a complete set of readings in according with the current range:

- pH, temperature and mV reading on pH range.

The answer string contains:

- Meter mode (2 chars):
 - 00 - pH range (0.001 resolution)
 - 01 - pH range (0.01 resolution)
 - 02 - pH range (0.1 resolution)
 - 03 - mV range
- Meter status (2 chars of status byte): represents a 8 bit hexadecimal encoding.
 - 0x10 - temperature probe is connected
 - 0x01 - new GLP data available
 - 0x02 - new SETUP parameter
 - 0x04 - out of calibration range
 - 0x08 - the meter is in autoend point mode

- Reading status (2 chars): R - in range, O - over range, U - under range. First character corresponds to the primary reading. Second character corresponds to mV reading.
- Primary reading (corresponding to the selected range) - 11 ASCII chars, including sign and decimal point and exponent.
- Secondary reading (only when primary reading is not mV) - 7 ASCII chars, including sign and decimal point.
- Temperature reading - 7 ASCII chars, with sign and two decimal points, always in °C.

MDR

Requests the instrument model name and firmware code (16 ASCII chars).

GLP

Requests the calibration data record.

The answer string contains:

- GLP status (1 char): represents a 4 bit hexadecimal encoding.
 - 0x01 - pH calibration available
- pH calibration data (if available), which contains:
 - the number of calibrated buffers (1 char)
 - the offset, with sign and decimal point (7 chars)
 - the average of slopes, with sign and decimal point (7 chars)
 - the calibration time, **yymmddhhmmss** (12 chars)
 - buffers information (for each buffer)
 - type (1 char): 0 - standard, 1 - custom
 - status (1 char): N (new) - calibrated in last calibration; O (old) - from an old calibration.
 - warnings during calibration (2 chars): 00 - no warning, 04 - Clean Electrode warning.
 - buffer value, with sign and decimal point and exponent (11 chars).
 - calibration time, **yymmddhhmmss** (12 chars).
 - electrode condition, with sign (3 chars). The “-01” code means not calculated.

PAR Requests the setup parameters setting.

The answer string contains:

- Instrument ID (4 chars)
- Calibration Alarm time out for pH (2 chars)
- SETUP information (2 chars): 8 bit hexadecimal encoding.
 - 0x01 - beep ON (else OFF)
 - 0x04 - degrees Celsius (else degrees Fahrenheit)
 - 0x08 - Offset calibration (else Point calibration)

- Auto Light Off time (3 chars)
- Auto Power Off time (3 chars)
- The number of custom buffers (1 char)
- The custom buffer values, with sign and decimal point, for each defined custom buffer (7 chars)
- The short name of the selected language (3 chars)

NSLx

Requests the number of logged samples (4 chars).

The command parameter (1 char):

- P - request for pH range

LODPxxx

Requests the xxxth pH record logged data.

LODPALL

Requests all pH Log on demand.

The answer string for each record contains:

- The logged mode (2 chars):
 - 00 - pH range (0.001 resolution)
 - 01 - pH range (0.01 resolution)
 - 02 - pH range (0.1 resolution)
 - 03 - mV range
- Reading status (1 char): R, O, U
- Calculated reading, with sign and decimal point and exponent (11 chars) - for pH
- Temperature reading, with sign and two decimal points (7 chars)
- mV reading status (1 char): R, O, U
- The mV reading, with sign and decimal point (7 chars)
- The logged time, **yymmddhhmmss** (12 chars)
- The calibration slope, with sign and decimal point (7 chars)
- The calibration offset, with sign and decimal point (7 chars)
- Temperature probe presence (1 char)

Notes: "Err8" is sent if the instrument is not in measurement mode.

"Err6" is sent if the requested range is not available.

"Err4" is sent if the requested set parameter is not available.

"Err3" is sent if the Log on demand is empty.

"Err9" is sent if the battery power is less than 30%.

Invalid commands will be ignored.

To replace the batteries, follow the next steps:

- Turn OFF the instrument.
- Open the battery compartment by removing the four screws from the back of the instrument.
- Remove the old batteries.
- Insert four new 1.5V AA batteries in the battery compartment while paying attention to the correct polarity.
- Close the battery compartment using the four screws.

If the battery capacity is less than 20 % the serial communication and the backlight feature are not available.

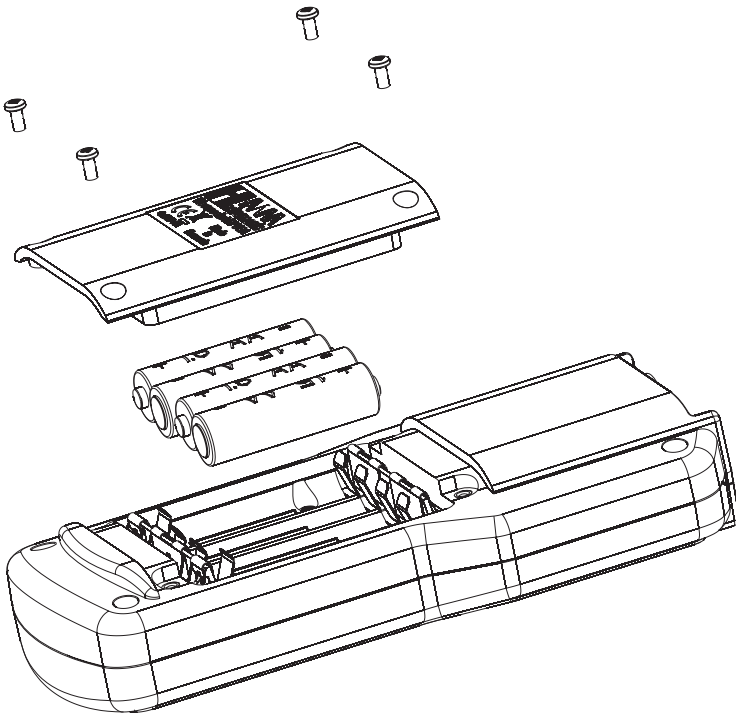

Note: The instrument is provided with the BEPS (Battery Error Prevention System) feature, which automatically turns the instrument off when the batteries level is too low to ensure reliable readings.

The resistance of glass electrodes partially depends on the temperature. The lower the temperature, the higher the resistance. It takes more time for the reading to stabilize if the resistance is higher. In addition, the response time will suffer to a greater degree at temperatures below 25 °C (77 °F).

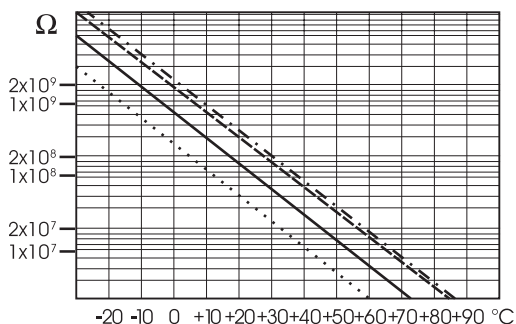

Since the resistance of the pH electrode is in the range of 50 – 200 MΩ, the current across the membrane is in the pico Ampere range. Large currents can disturb the calibration of the electrode for many hours.

For these reasons high humidity environments, short circuits and static discharges are detrimental to a stable pH reading.

The pH electrode’s life also depends on the temperature. If constantly used at high temperatures, the electrode life is drastically reduced.

Typical Electrode Life

- Ambient Temperature 1 – 3 years
- 90 °C (194 °F) Less than 4 months
- 120 °C (248 °F) Less than 1 month

Alkaline Error

High concentrations of sodium ions interfere with readings in alkaline solutions. The pH at which the interference starts to be significant depends upon the composition of the glass. This interference is called alkaline error and causes the pH to be underestimated. Hanna’s glass formulations have the indicated characteristics.

Sodium Ion Correction for the Glass at 20-25 °C (68-77 °F)		
Concentration	pH	Error
0.1 Mol L ⁻¹ Na ⁺	13.00	0.10
	13.50	0.14
	14.00	0.20
1.0 Mol L ⁻¹ Na ⁺	12.50	0.10
	13.00	0.18
	14.00	0.40

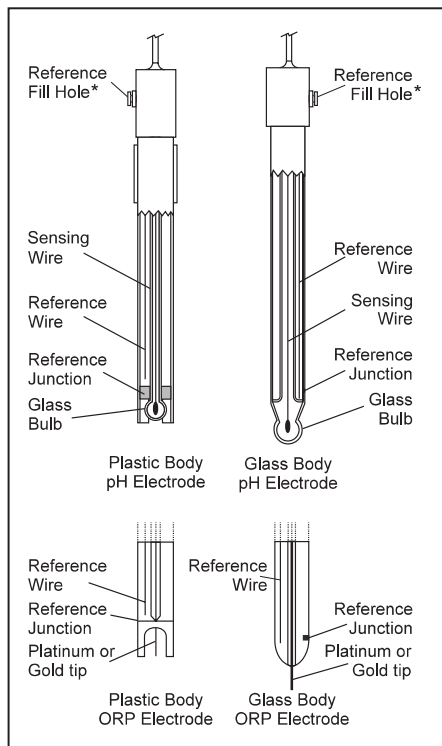

*Not present in gel electrodes.

PREPARATION PROCEDURE

Remove the electrode protective cap.

DO NOT BE ALARMED IF ANY SALT DEPOSITS ARE PRESENT. This is normal with electrodes and they will disappear when rinsed with water.

During transport tiny bubbles of air may have formed inside the glass bulb. The electrode cannot function properly under these conditions. These bubbles can be removed by "shaking down" the electrode as you would do with a glass thermometer.

If the bulb and/or junction are dry, soak the electrode in [HI70300](#) Storage Solution for at least one hour.

For refillable electrodes:

If the filling solution (electrolyte) is more than 2½ cm (1") below the fill hole add [HI7082](#) or [HI8082](#) 3.5M KCl Electrolyte Solution for double junction electrodes.

For faster response, unscrew the fill hole screw during measurements.

MEASUREMENT

Rinse the pH electrode tip with distilled water. Immerse the tip (bottom 4 cm / 1½" ensuring the reference junction is submerged) in the sample and stir gently for a few seconds.

For a faster response and to avoid cross-contamination of the samples, rinse the electrode tip with a few drops of the solution to be tested, before taking measurements.

STORAGE PROCEDURE

To minimize clogging and assure a quick response time, the glass bulb and the junction of pH electrode should be kept moist and not allowed to dry out.

Replace the solution in the protective cap with a few drops of [HI70300](#) or [HI80300](#) Storage Solution or, in its absence, Filling Solution ([HI7082](#) or [HI8082](#) for double junction electrodes). Follow the Preparation Procedure on page 44 before taking measurements.

Note: NEVER STORE THE ELECTRODE IN DISTILLED OR DEIONIZED WATER.

PERIODIC MAINTENANCE

Inspect the electrode and the cable. The cable used for connection to the instrument must be intact and there must be no points of broken insulation on the cable or cracks on the electrode stem or bulb. Connectors must be perfectly clean and dry. If any scratches or cracks are present, replace the electrode.

Rinse off any salt deposits with water.

pH Probe Maintenance

For refillable electrodes:

Refill the reference chamber with fresh electrolyte [HI7082](#) or [HI8082](#) for double junction electrodes.

Allow the electrode to stand upright for 1 hour.

Follow the Storage Procedure above.

pH CLEANING PROCEDURE

- General Soak in Hanna [HI7061](#) or [HI8061](#) General Cleaning Solution for approximately ½ hour.
- Protein Soak in Hanna [HI7073](#) or [HI8073](#) Protein Cleaning Solution for 15 minutes.
- Inorganic Soak in Hanna [HI7074](#) Inorganic Cleaning Solution for 15 minutes.
- Oil/grease Rinse with Hanna [HI7077](#) or [HI8077](#) Oil and Fat Cleaning Solution.

Instruction for Application Cleaning Solution

1. Add in a beaker about 50 - 75 mL (or minimum to cover the electrode junction) one of the following cleaning solution:
 - Cleaning and Disinfection Solution for Dairy Products (HI70641);
 - Cleaning and Disinfection Solution for Yogurt Products (HI70643);
 - Acid Cleaning Solution for Meat, Grease and Fats (HI70630);
 - Cleaning Solution for Cheese Deposits (HI70642);
 - Alkaline Cleaning Solution for Meat, Grease and Fats (HI70631);
 - Cleaning Solution for Milk Deposits (HI70640).
2. Soak the electrode for several minutes (5 - 15) while moderately stirring the solution.
3. Remove the electrode from the cleaning solution and rinse it thoroughly with deionized water to remove all traces of the cleaning solution.
4. After cleaning and rinsing it is preferable to store it in an electrolyte solution for about 1 hour.
5. Rinse the electrode thoroughly with deionized water and measure samples as usual.

Note: If the electrode response is slow or the electrode does not calibrate correctly, repeat the cleaning procedure.

IMPORTANT: After performing any of the cleaning procedures, rinse the electrode thoroughly with distilled water, refill the reference chamber with fresh electrolyte (not necessary for gel-filled electrodes) and soak the electrode in **HI70300** or **HI80300** Storage Solution for at least 1 hour before taking measurements.

SYMPTOMS	PROBLEM	SOLUTION
Slow response/excessive drift.	Dirty pH electrode.	Soak the electrode tip in HI7061 solution for 30 minutes and then follow the Cleaning Procedure.
Reading fluctuates up and down (noise).	Clogged/dirty junction. Low electrolyte level (refillable electrodes only).	Clean the electrode. Refill with fresh electrolyte (refillable electrodes only).
Display shows blinking full scale value.	Reading out of range.	Check that sample is within measurable range
Display shows " Clean electrode " blinking.	Difference between new and previous calibration has been detected.	Clean electrode and recalibrate. If the problem remains, check the buffer solutions.
Meter fails to calibrate or gives faulty readings.	Broken pH electrode.	Replace electrode.
Error messages are displayed during pH calibration procedure.	Wrong or contaminated buffer, electrode dirty or broken.	Check that buffer solution is correct and fresh.
Meter shuts off.	Dead accumulators; Auto-off feature is enabled: in this case, meter shuts off after selected period of non-use.	Recharge accumulators or replace batteries; Press ON/OFF .
"Errxx" message at start up.	Internal error.	Contact your local Hanna Instruments Office.
The instrument does not start when pressing ON/OFF .	Initialization error.	Press and hold down ON/OFF for about 20 seconds or disconnect and then connect one accumulator.

Electrode Cleaning Solution

Code	Description
HI70000P	Electrode Rinse Solution, 20 mL sachet, 25 pcs.
HI700601P	General purpose cleaning solution for laboratories, 20 ml sachet, 25 pcs.
HI700630P	Acid cleaning solution for meat grease and fats (food industry), 20 mL sachet, 25 pcs.
HI700640P	Cleaning solution for milk deposits (food industry), 20 mL sachet, 25 pcs.
HI700641P	Cleaning and disinfection solution for dairy products (food industry), 20 mL sachet, 25 pcs.
HI700642P	Cleaning solution for cheese residues (food industry), 20 mL sachet, 25 pcs.
HI700643P	Cleaning and disinfection solution for yogurt products (food industry) 20 mL sachet, 25 pcs.
HI7061L	General Purpose Cleaning Solution, 500 mL bottle
HI7073L	Protein Cleaning Solution, 500 mL bottle
HI7074L	Inorganic Cleaning Solution, 500 mL bottle
HI7077L	Oil and Fat Cleaning Solution, 500 mL bottle
HI8061L	General Purpose Cleaning Solution, FDA approved bottle, 500 mL
HI8073L	Protein Cleaning Solution, FDA approved bottle, 230 mL
HI8077L	Oil and Fat Cleaning Solution, FDA approved bottle, 500 mL
HI70630L	Acid cleaning solution for meat grease and fats (food industry), 500 mL bottle
HI70631L	Alkaline cleaning solution for meat grease and fats (food industry), 500 mL bottle
HI70640L	Cleaning solution for milk deposits (food industry), 500 mL bottle
HI70641L	Cleaning and disinfection solution for dairy products (food industry), 500 mL bottle
HI70642L	Cleaning solution for cheese residues (food industry), 500 mL bottle
HI70643L	Cleaning and disinfection solution for yogurt products (food industry), 500 mL bottle

pH Calibration Solution

Code	Description
HI50004-01	pH 4.01 Buffer Solution, 20 mL sachet, 10 pcs.
HI50004-02	pH 4.01 Buffer Solution, 20 mL sachet, 25 pcs.
HI50007-01	pH 7.01 Buffer Solution, 20 mL sachet, 10 pcs.
HI50007-02	pH 7.01 Buffer Solution, 20 mL sachet, 25 pcs.
HI50010-01	pH 10.01 Buffer Solution, 20 mL sachet, 10 pcs.
HI50010-02	pH 10.01 Buffer Solution, 20 mL sachet, 25 pcs.
HI5016	pH 1.68 Buffer Solution, 500 mL bottle
HI5004	pH 4.01 Buffer Solution, 500 mL bottle
HI5068	pH 6.86 Buffer Solution, 500 mL bottle
HI5007	pH 7.01 Buffer Solution, 500 mL bottle
HI5091	pH 9.18 Buffer Solution, 500 mL bottle
HI5010	pH 10.01 Buffer Solution, 500 mL bottle
HI5124	pH 12.45 Buffer Solution, 500 mL bottle
HI8004L	pH 4.01 Buffer Solution in FDA approved bottle, 500 mL
HI8006L	pH 6.86 Buffer Solution in FDA approved bottle, 500 mL
HI8007L	pH 7.01 Buffer Solution in FDA approved bottle, 500 mL
HI8009L	pH 9.18 Buffer Solution in FDA approved bottle, 500 mL
HI8010L	pH 10.01 Buffer Solution in FDA approved bottle, 500 mL

Electrode Storage Solution

HI70300L	Storage Solution, 500 mL bottle
HI80300L	Storage Solution in FDA approved bottle, 500 mL

Other Accessories

Code	Description
FC2423	PVDF body, pH probe with internal temperature sensor
HI92000	PC Software
HI920015	USB Cable
HI740157P	Electrode refilling pipette
HI8427	pH/mV electrode simulator with 1 m(3,3') coaxial cable ending in female BNC connectors
HI931001	pH/mV electrode simulator with LCD and 1 m(3,3') coaxial cable ending in female BNC connectors
HI720165	Hard carrying case

Warranty

The HI98165 is warranted for two years against defects in workmanship and materials when used for their intended purpose and maintained according to instructions. Electrodes and probes are warranted for six months. This warranty is limited to repair or replacement free of charge.

Damage due to accidents, misuse, tampering or lack of prescribed maintenance is not covered.

If service is required, contact your local Hanna Instruments Office. If under warranty, report the model number, date of purchase, serial number and the nature of the problem. If the repair is not covered by the warranty, you will be notified of the charges incurred. If the instrument is to be returned to Hanna Instruments, first obtain a Returned Goods Authorization (RGA) number from the Technical Service department and then send it with shipping costs prepaid. When shipping any instrument, make sure it is properly packed for complete protection.

Hanna Instruments reserves the right to modify the design, construction or appearance of its products without advance notice.

World Headquarters

Hanna Instruments Inc.
Highland Industrial Park
584 Park East Drive
Woonsocket, RI 02895 USA
www.hannainst.com

Local Office

Hanna Instruments USA
270 George Washington Highway
Smithfield, RI 02917
Phone: 800.426.6287
Fax: 401.765.7575
e-mail: tech@hannainst.com

